

# Installation Instruction

## ELECTRONIC BIDET TOILET

WOODBIDGE®

Model: EBT-WH01  
EBT-HB02  
EBT-MB03

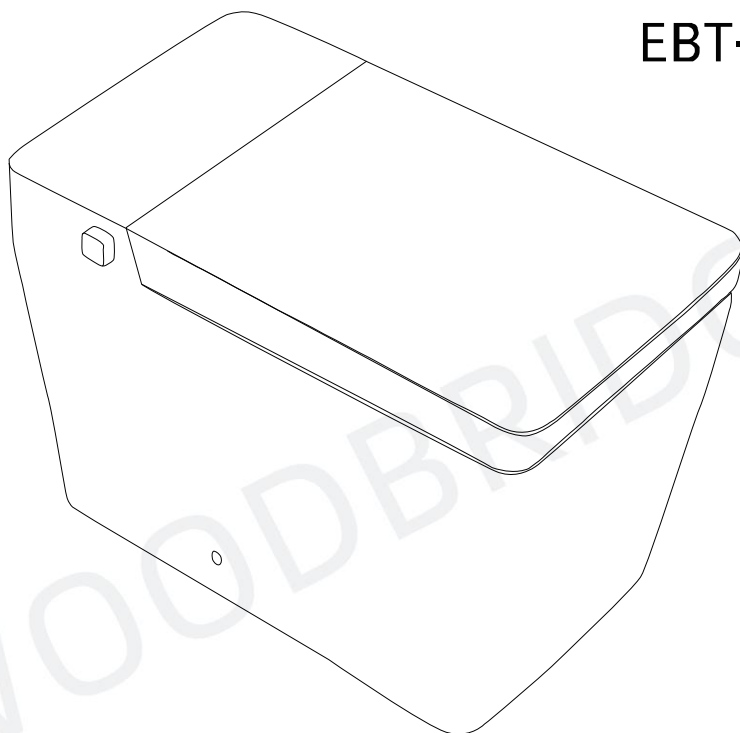

**READ ALL INSTRUCTIONS BEFORE UNPACKING THE PRODUCT**

INSTRUCTIONS THAT, IF IGNORED, COULD RESULT IN DEATH OR SERIOUS INJURY CAUSED BY INCORRECT HANDLING OR INSTALLATION OF THE PRODUCT. THESE INSTRUCTIONS MUST BE OBSERVED FOR SAFE INSTALLATION.

**CAUTION!**



**TWO PEOPLE  
LIFT REQUIRED**

**2 PEOPLE ARE REQUIRED TO LIFT AND DURING  
ENTIRE INSTALLATION OF THIS PRODUCT**

This product must be installed by a fully insured and licensed installer.

We are not responsible for local code compliance for this product. Building and plumbing codes may vary from state-to-state in accordance to your location. We are not responsible for providing any compliance certifications.

Under no circumstances we are liable for any and all incidental damages sustained in connection with this product. Neither manufacturer, distributor or retailer is responsible for water damage or flood caused by the usage of this product.

Under no circumstances we are liable for any and all fees, cost of installation/reinstallation/removal, subsequent damages or transportation in case of the product defect.

# TOILET COMPONENTS

During unpacking the product and prior to installation inspect your new product for any damages or missing parts. Do not attempt to install or operate the product if the product is damaged.

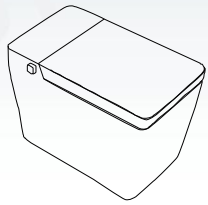

Bidet toilet x1

- bolt cap decoration x2
- Remote control x1
- Plastic Washer x2
- Flange Ring x1
- Angle valve x1
- Mounting Screw x2
- Backup battery box x1

# TOOLS REQUIRED FOR INSTALLATION

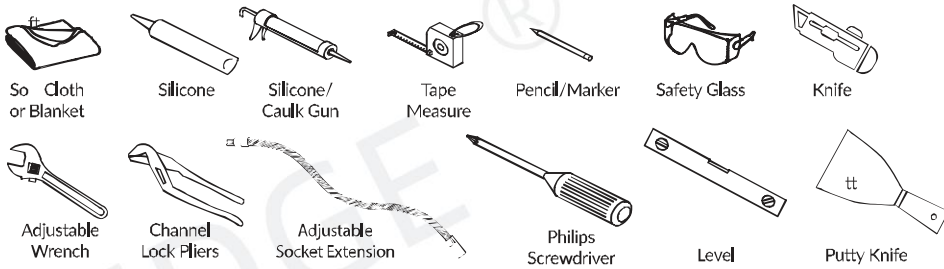

OTHER TOOLS MAY BE REQUIRED

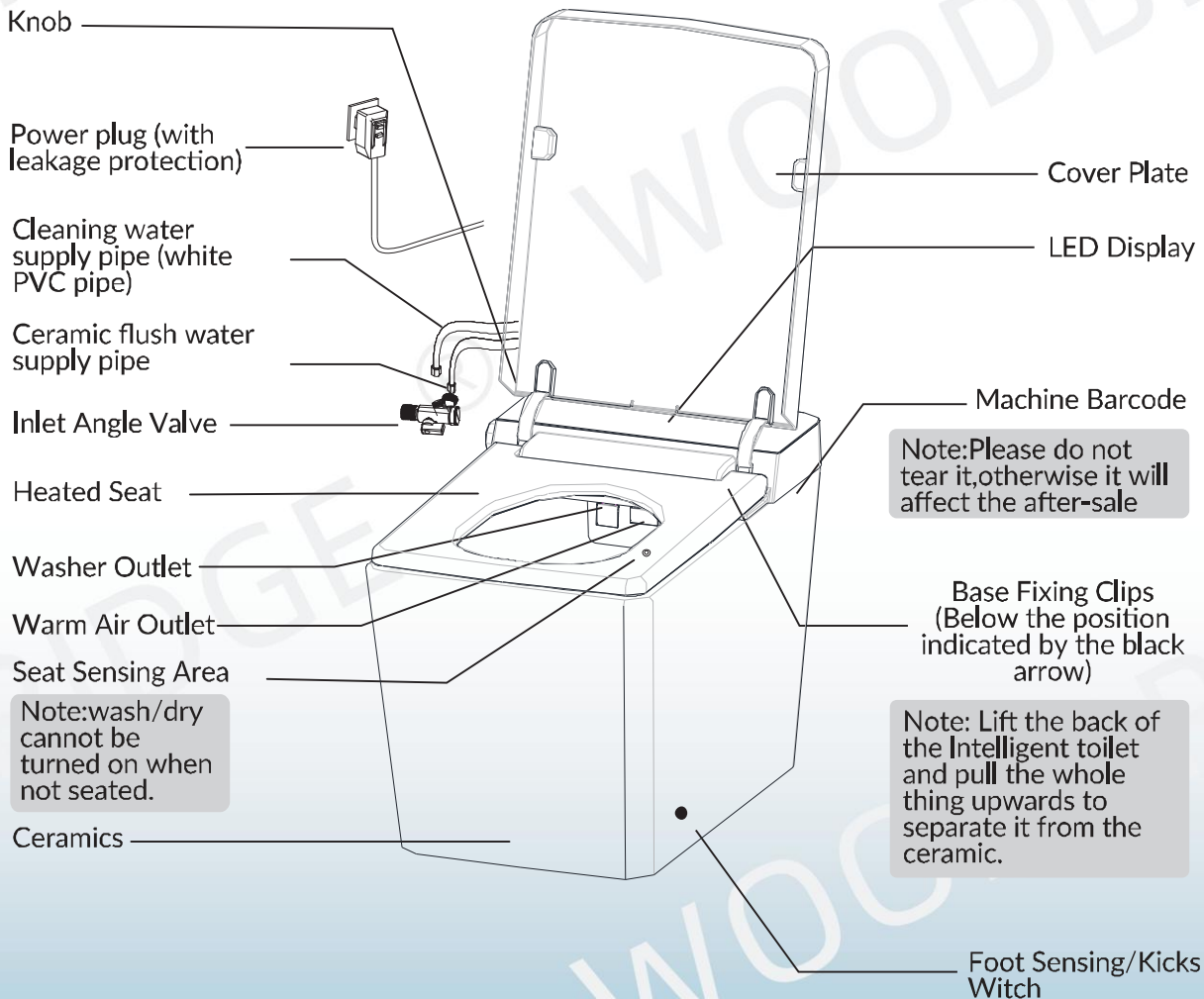

## Installation Guide

Product Size

unit: inch

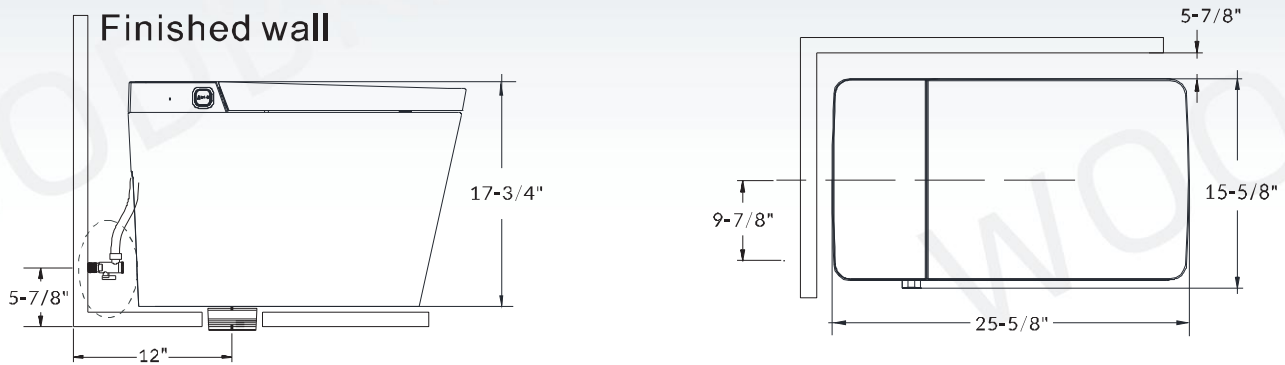

## Installation Diagram

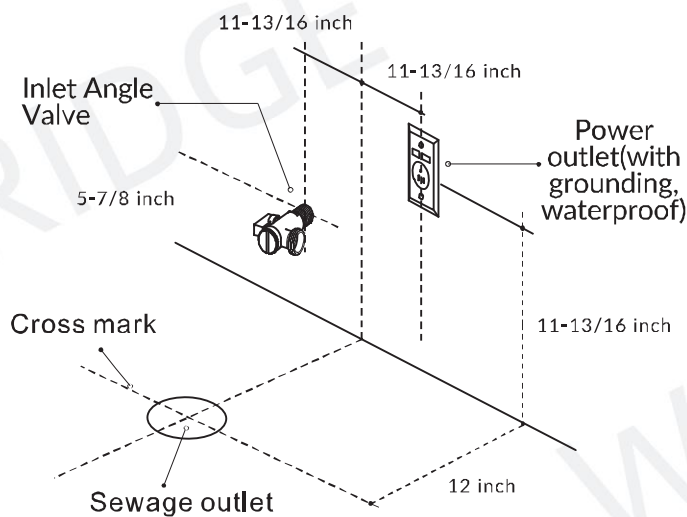

Be sure to set the power outlet as follows :

1. Confirm that the power socket used is handled by proper grounding.
  2. The length of the power cord is 1.5m, and the location of the socket should be close to this product to facilitate installation and removal, and as far away from the bathtub as possible.
  3. It is recommended to use a waterproof type socket, do not use an extension cord to connect this product.
- May cause fire or electrical shock.



Warning

## Pre-Installation Instructions

1. Test the water pressure: water must be more than 3 liters in 10 seconds, and the flow rate is stable.
2. Before installing the water inlet pipe, the water pipe must be drained for 2-5 minutes, in order to prevent the pipeline impurities into the product, which may lead to product damage.



## Installation Steps

1. Draw a cross mark parallel and perpendicular to the wall at the center of the sewage outlet on the floor.

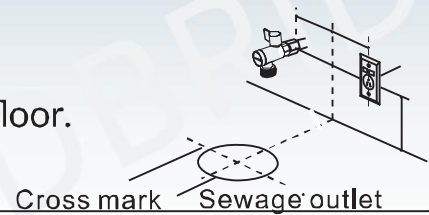

2. Place the ceramic body on its side on the pre-prepared foam. Visually, mark the line on the side of the ceramic that corresponds to the center point of the ceramic sewer outlet as shown on the right.

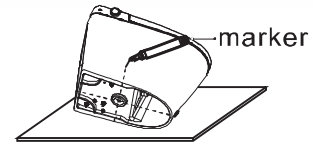

3. Install the flange ring on the ceramic bottom drain and make a tight connection. Note: If necessary, put glass glue on the top and bottom of the flange ring.

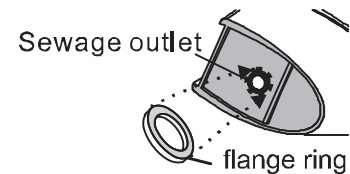

4. Before installing the toilet, the sewage pipe should be thoroughly inspected to see whether there is mud, sand, waste paper and other debris clogged in the pipe, and the floor should be cleaned and dried at the same time.



5. Two people lift the ceramic, align the mark on the ceramic body with the cross mark on the ground, and slowly place the ceramic on the ground so that the two marks coincide. After the overlap, press the ceramic body downward so that the putty fully touches the ground and connects tightly with the ground. Do not move the ceramic body or rock it from side to side after the marks have coincided, otherwise the seal created by the putty may be broken, resulting in water leakage.

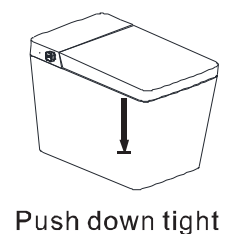

6. Screw installation  
Put the screw through the fixing sleeve and then install it through the holes (on both sides of the toilet ceramic) to the mounting bracket on the ground, and lock tight with a tool;

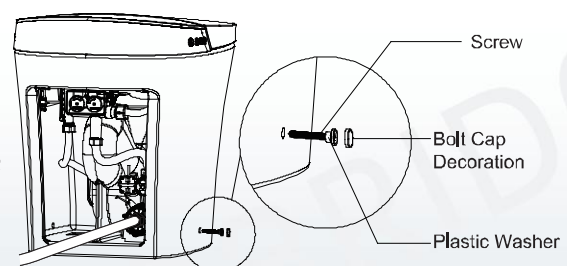

Put the decorative cap on the fixing sleeve

7. Install the water inlet angle valve. Note: Installation of water inlet angle valve before depending on the water quality must be drained for 2 to 5 minutes



## Plumbing installations

Connect one end of the braided hose to the angle valve, when connecting, please do not tighten too much, otherwise it will damage the sealing ring and lead to water leakage in the pipeline.

### Caution:

1. If the cleaning water line and ceramic flushing water line are separate models, two lines must be connected to the angle valve.
2. Open the water inlet angle valve to the maximum, make sure there is no water leakage in each connection part, if found leakage, please re-install.
3. Do not enter the pipe sealing material into the internal pipeline, otherwise it may cause the whole machine failure.

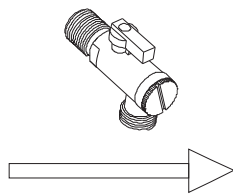

Remove the old water inlet angle valve and replace it with a new one.  
**old water inlet angle valve**

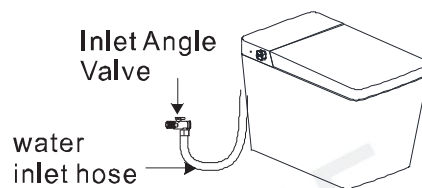

Note: The water inlet hose must not be folded, otherwise the water pressure will be too low and the product will not work properly.

Installation Method A: Copper water supply installation (copper tube is not included, and can be find in hardware store)

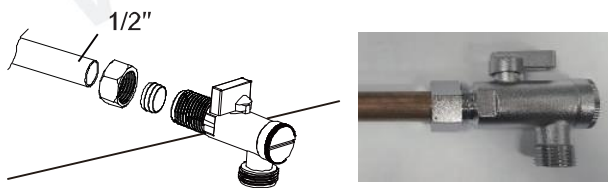

Installation Method B: Dog Ear 90 installation



Note: This product adopts the super whirlpool siphon jet flushing technology, such as higher water pressure area (more than 0.3MPa) when using, ceramic wall will appear a little splash if the jet is too strong, jet noise is too large, you can lowly adjust the water inlet angle valve, reduce the water pressure, improve the above situation.

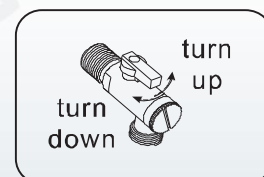

### Caution:

In case of power failure during use, please close the angle valve and stop the water supply, and the function will be restored to normal after self-test after the incoming call

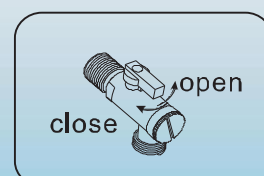

## Installation of the remote control

### Installation method

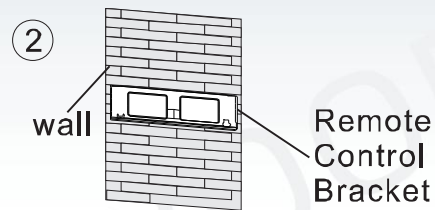
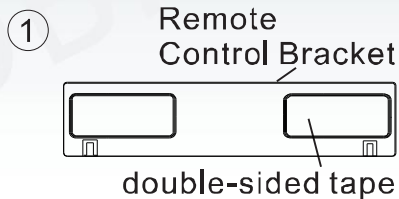

### Attention:

1. The installation location must be cleaned before pasting, press the tape hard and evenly when pasting, and use it after 15 minutes.
2. Double-sided adhesive tape is suitable for pasting tile-type flat wall, not suitable for pasting wallpaper-type wall.
3. The remote control should be installed in a place where it is not easy to be drenched by water.

### Test Run

The first time you turn on the water and power, wait until the machine self-test is completed, use the following steps

#### 1. Human Seat Sensor Function Test

The area shown in the picture is the human body seating sensing area, when you turn on the washing and drying function, you must be seated. When you are seated, you will hear a "Beep" to indicate that you are seated.

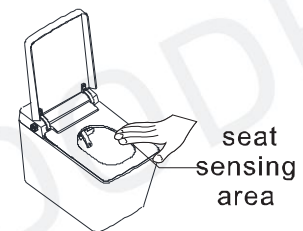

#### 2. Check the basic functions

Operate the knob or the remote control "Rear Wash", "Feminine Wash/Move", "Dry", "Flush", Each function should be normal, and there should be no water leakage, odor and noise and other undesirable phenomena.

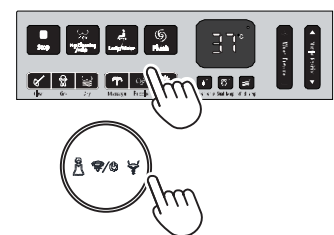

### Fixed Products

After the product functions normally, fill the uneven part of the ground with filler to make the ceramics stable, and use the caulking gun and caulk along the bottom of the ceramics.

**Important note: After the product is glued, please use it after 48h.**

## Side Control Panel Description



**Hip cleaning button:** When seated, rotate forward briefly once to turn on the hip wash and the knob shows blue light. After 3 minutes of powering-up, when leaving the seat, turn the ambient light on by rotating forward once in a short circle. **Valid only for models equipped with ambient lighting.**



**Stop button:** Long press the stop button to turn on/off the machine. When washing or drying is on, short press this button to stop washing or drying function. When leaving the seat, short press once, flush once. When power off, short press once, flush once.



**Lady button:** When seated, turn knob backwards briefly once to turn on the lady washing, the knob shows green light. After 3 minutes of powering-up, when leaving the seat, turn the ambient light off by rotating backward once in a short circle.

## LED Display Description

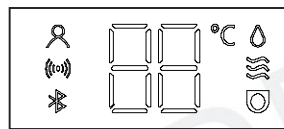

**Water Temperature Indication Icon:** When adjusting the water temperature, the icon lights up and the temperature display shows "--°C" (room temperature), "34°C" (low), "37°C" (medium), "40°C" (high).



**Wind temperature indicator icon:** when adjusting the wind temperature, the icon lights up, and the temperature shows "--°C" (room temperature), "35°C" (low), "45°C" (medium), "55°C" (high).



**Seat temperature indicator icon:** when adjusting the seat temperature, the icon lights up and the temperature display "--°C" (room temperature), "34°C" (low), "37°C" (medium), "40°C" (high).



**Temperature display icon:** displays the temperature for water, seat and air temperature.



**Microwave indicator icon:** when the microwave is on, the icon is lit; when the microwave is off, the icon is off.



**Seating Indicator Icon:** This icon lights up when you are seated.

**Warm tips:** standby time more than 5 minutes, ambient light, display automatically off, when there is a seat, remote control, foot feel/kick, knob and other operations, the ambient light (must be in the state of on) and the display will be re-illuminated.

## Remote Control Instructions

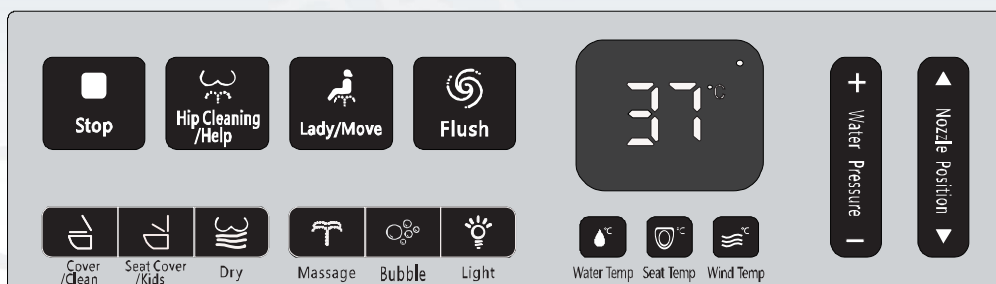

### Remote Control Code

Long press the "Lady/Move button", wait for the remote control display upper right corner of an indicator light blinking, the whole machine is powered on, about 10 seconds after the completion of the code.

**Note: When the code is set, the intelligent toilet must be energized within the time when the indicator lights of the remote control are blinking, otherwise it will be re-operated according to the above requirements.**



#### Stop button

Short press the "stop button" to stop the feminine / move washing, lady washing and drying functions.

#### Hip Cleaning/Help button

When seated, short press the "hip cleaning/Help button" to start hip wash, the a blue light will appear on the knob Press once more to start reciprocal washing. The cleaning time is 90s, after the automatic end, the flushing and drying will be activated.



When seated, press the "hip cleaning/Help button" for 3s to turn on the laxative function. Press the "Water Pressure button" to adjust the the pressure of the rear wash



**Important Safety Tips: When you turn on the function, the water pressure is higher than the normal rear wash water pressure, and the water column is more concentrated, please make sure to adjust to your own suitable water pressure, especially when children use it. If you feel uncomfortable, please immediately press the "stop button" to stop the function or press the "Water Pressure - button" to reduce the water pressure.**



#### Lady/Move button

When seated, short press the "Lady/Move button" to turn on the lady wash and the knob lights up in green. Press the button again to turn on reciprocal washing.

Cleaning time is 90s, start flushing and drying after automatic end.



#### Flush button

Press the "flush button" to flush the toilet once.



## Remote Control Instructions

### Remote control display



1. When code pairing, one indicator light in the upper right corner blinks at the same time, indicating that the remote control enters the code pairing mode.
2. Display the temperature of water, seat and air temperature in each gear.



### Water Pressure button

During the cleaning process, press the "+" button to increase the cleaning strength, and press the "-" button to decrease the cleaning strength.



### Nozzle position button

To change the cleaning position, press the "Nozzle position / button" to move the front and rear positions of the nozzle.



### Cover button

1. Short press the "Cover button" to open/close the cover.
2. When you leave the seat, long press "Cover button", the cleaner extends, can carry out nozzle cleaning, press the stop button to end the nozzle cleaning.



**On the remote control the button is "self cleaning button", short press can open the nozzle cleaning.**



### Seat cover button

Press the "Seat Cover button" to open/close the seat ring. Long press the "Seat Cover button" to enable the child wash function, the water pressure is low; the water temperature is set at 37°C; the seat temperature and air temperature are adjustable up to the middle; the washing position is adjustable.



The washing time is 90s, and the rinsing and drying are activated after the automatic end.

**Manual model remote control button for the "Kids button", short press to open the child wash.**



### Dry button

When seated, press the "dry button" to start drying and dry the cleaning part for 3 min.



### Massage button

Pressing the "massage button" in wash mode alternates between strong and weak water pressure. This function is only available in wash mode.



### Light button

Short press the "Light button" to turn on/off the night light.

## Remote Control Instructions



Water Temp

### Water temp button

Press the "Water temp button" to adjust the cleaning water.



Seat Temp

### Seat Temp button

Press the "Seat temp button" to adjust the seat temperature.



Wind Temp

### Wind temp button

Press the "Wind Temp button" to adjust the warm air temperature.

## Microwave Sensor Functions

### Scene 1

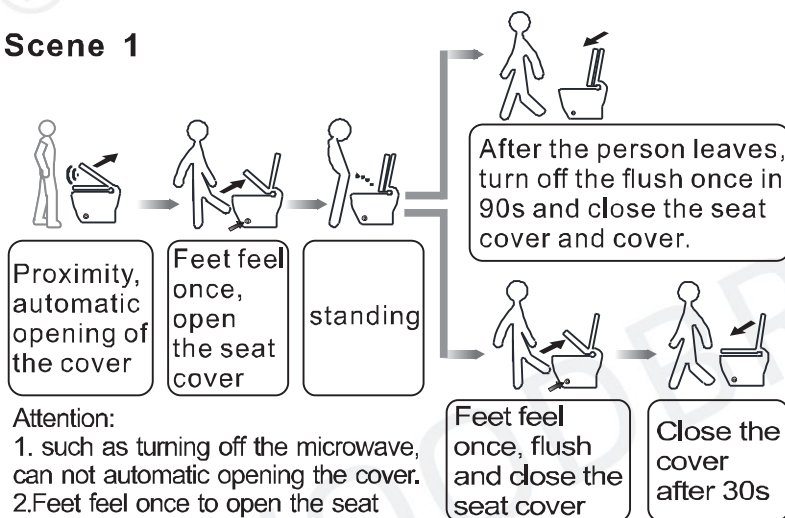

#### Attention:

1. such as turning off the microwave, can not automatic opening the cover.
2. Feet feel once to open the seat cover, and then feet feel once to open the seat.

### Scene 2

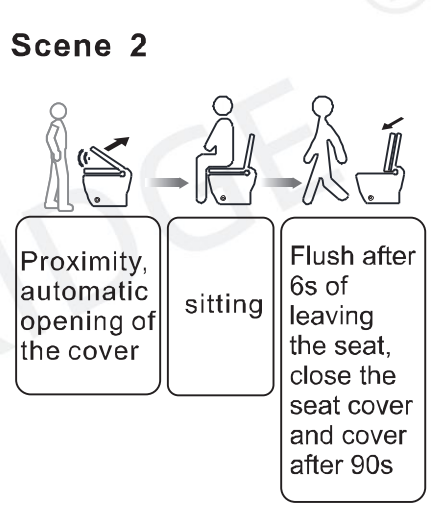

## Hide Adjustment Functions

### 1. Microwave on/off operation method:

Power on within 2 minutes, long press the remote control "stop button", hear "tick" a long sound, open the microwave; long press "stop button", hear "tick" a short sound, turn off the microwave.

After the microwave is turned off, the cover will not be opened automatically.



long press 3s

### 2. Ceramic flushing water consumption adjustment operation :

Within 2 minutes of power on, long press the remote control "flush button", enter the water consumption adjustment mode, and then short press the remote control "flush button", water consumption adjustment of a gear, the display cycle shows F1 (minimum water consumption) / F2 (mid-range water consumption) / F3 (high-grade water consumption).

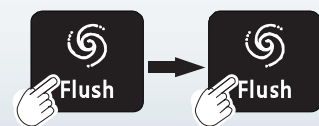

long press 3s

Short press again

### 3. Microwave induction distance adjustment:

Within 2 minutes of power on, long press the remote control "light button" for 3 seconds, you will hear a "tick", enter the microwave sensing distance adjustment mode, and then short press the "light button" to adjust the distance one gear. A total of six gears are set, one sound, the microwave sensing distance is the closest, six sounds, the microwave sensing distance is the farthest.

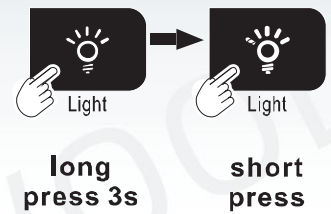

### 4. Four-season temperature-sensitive self-control operation method:

Long press the remote control "▲" 3 seconds, hear the "tick" sound, the knob shows light yellow, said to open the four seasons temperature sensing self-control function; and then long press "▲" 3 seconds, hear the "tick" two short sound, said to exit the four seasons temperature sensing selfcontrol function, or press the remote control of the water temperature button, the seat temperature button, the wind temperature button of any button, will be out of the four seasons temperature sensing self-control function.



Four Season Temperature Control			
Environmental Temp	Water Temp	Seat Temp	Wind Temp
< 15°C	40°C	40°C	55°C
15°C~20°C	37°C	37°C	55°C
20°C~25°C	37°C	34°C	45°C
25°C~32°C	34°C	--°C	35°C
> 32°C	--°C	--°C	--°C

### 5. seat cover and cover drop time gear adjustment:

Gear one: long press "▼", hear "tick" sound, when the human body leaves the induction area, the cover time is 90s, after the foot sensing fall circle, the cover time is 30s, the factory default gear.

Gear two: long press "▼", hear the "tick" two sound, the human body leaves the induction area, drop cover time is 30s, foot drop circle, drop cover time is 15s.



 <b>Caution</b>	<b>If the microwave is turned off, be sure to adjust the setting to "gear one".</b>
--------------------	---

## Replacing the Remote Control Battery

When the batteries are exhausted, the remote control will not be sensitive or out of control, please replace the batteries in time.

### Caution

Compress the spring on the negative side of the remote control to remove the batteries and install the batteries according to the positive and negative requirements. Please use alkaline batteries and do not mix old and new batteries.

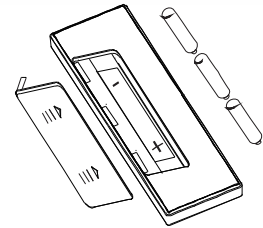

#### Caution:

1. The remote control will be damaged when it gets into water or dropped.
2. There are batteries in the remote control, please store it properly out of the reach of young children.
3. Replace the old batteries, place them out of children's reach and please dispose of them properly and in a timely manner.

## Replacement of Backup Batteries

### Steps

1. Pull out the power plug.
2. Locate the battery box at the rear of the machine and disconnect the battery box connector from the machine connector as shown by the arrow on the right.
3. Remove the cover of the battery box and install the appropriate batteries as required.
4. Re-insert the battery box connector with the whole machine connector.
5. Press the flush button to make sure it flushes properly.

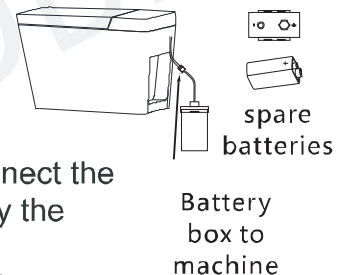

### Caution

1. 9V alkaline battery box must be used for models without water tank (batteries can be replaced), and 12V lithium battery box for models with water tank (batteries cannot be replaced).
2. If the backup battery is not installed, the power failure flushing function cannot be activated; if the battery power is low, the flushing valve cannot be turned on and off normally, which may lead to indoor flooding in serious cases, so please pay attention to it.
3. The power failure flush function is only for emergency use during power failure, please do not use it for a long time without power.
4. Replace the old batteries and keep them out of the reach of young children and dispose of them properly in time.

## Troubleshooting

failures	Inspection methods	Troubleshooting
Product does not work	Check that the leakage protection power cord indicator light is on?	If not illuminated, check the external power supply to the circuit.
	Is the leakage protection power cord indicator light on and is it on?	Re-power on, or long press the knob for 3s to turn on the machine.
No water from nozzle	Check for water outages?	Pending restoration of water supply.
	Check that the angle valves are closed?	Open the angle valve.
	Check for clogged filters?	Cleaning filters.
	Check the inlet hose for bends?	Eliminate bent inlet pipes.
Insufficient cleaning strength	Check that the wash water pressure is set at a low setting?	Adjust the wash water pressure level according to the instructions.
	Check for clogged angle valve filters?	Cleaning filters.
Washer nozzle dripping	Does the water not drip after closing the angle valve?	Replace the water inlet solenoid valve, clean the angle valve filter.
Washing and drying functions do not work	Check to make sure it's tight against the seat sensing area?	Tight fit, still not working, the seating sensor is not working, replace the seating ring.
When drying, blowing cold air	Check that the warm air is set at room temperature?	Adjust the air temperature setting by referring to the instruction manual.
	Warm air heating parts are not damaged?	Replacement of drying assembly.
Water and seat temperature not heating	Check that the water and seat temperatures are set at room temperature?	Adjust the water and seat temperature settings according to the instructions.
malfunction of the remote control	Check if the remote control indicator light does not light up or is noticeably dimmed?	Replace with new batteries and install correctly.
Ceramics don't flush clean	Check for low external water pressure?	Pending restoration of water supply.
	Check for clogged angle valve filters?	Cleaning Angle Valve Filter.
	Check the inlet hose for bends?	Eliminate bent inlet pipes.
Water pressure is normal, flushing is not clean	Check for air leaks at the drain?	Re-installation.
	Check for blocked S-bends?	Purchase a tool to unclog it, such as a leather bolt, to unclog it.
Normal water pressure, no flush	Is there any beep on the main board when you press flush?	Yes, replace flushing components such as pulse valves.
	Is there any beep on the main board when you press flush?	No, replace related parts such as motherboard or remote control.
Cover/seat cover falling too fast	Can it be restored to normal after flipping the cover and ring into place?	Cannot be restored, replace damping assembly.
Sequential cycling of functions	Check if you have entered the engineering debug mode by mistake?	Unplugged and re-energized after one minute.

## Daily Maintenance Methods

### Bidet Toilet Cleaning

Use a soft, moist cloth to wring it out and wipe it, if necessary, you can use a cloth with neutral detergent to wipe it, make sure to dry it with a soft cloth after cleaning.

**Caution:** The product material is new plastic material, itself will not change color. The vast majority of discoloration phenomenon is oxidation, such as product contact with perfume, toilet bowl cleaner, nail polish and other liquids, did not wipe off in a timely manner, resulting in product surface oxidation. Individual users in the seat placed on the seat cushion, cushion and seat contact surface is generally non-slip rubber, long-term heat and high humidity in the environment, so that the seat contact position discoloration.

### Ceramic Cleaning

Use a soft, moist cloth wrung out and wiped, when the ceramic dirt is serious, you can appropriate ceramic special cleaner to clean the dirt.

**Caution:** Do not use chlorine-based cleaners and acidic cleaners.

### Nozzle cleaning

1. Please clean the nozzle regularly: prepare a toothbrush and a soft cloth, leave the seat, press the "cleaning button" of the remote control (due to the different models, the operation mode is different, see P15 operation method), the spray bar is extended. 2. Hold the spray bar of the cleaner, use toothbrush and soft cloth to clean the spray bar and nozzle.

**Note:** Do not use excessive force, otherwise the spray rod or nozzle will be damaged.

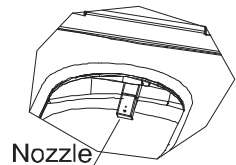
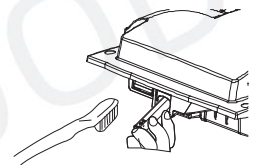

### Angle valve filter cleaning

1. For your health, please clean the filter (or replace the filter) in time according to the local water quality.

2. Please clean the filter (or replace the filter) in time when the cleaning strength is found to be weakened. Unscrew the filter with a one-dollar coin by rotating it counterclockwise, clean it with a toothbrush, etc. and then reattach it to the inlet angle valve.

**Caution:**

It is recommended to clean the filter once every 1~2 months.

Do not reuse broken filters.



⚠ **Caution:**

It is strictly prohibited to rinse the product with water during maintenance.

## Product Specification

Product Name		Intelligent Toilet	
Cleaning devices	Input voltage	~110V 50/60Hz	
	Water inlet temperature	4°C~35°C	
	Inlet water pressure	0.14MPa~0.75MPa	
	Temperature of warm water	Four-stage adjustment (room temperature gear ~ about 40°C)	
	Cleaning flow rate	Hip cleaning	Approx. 0.5~0.8 l/min (dynamic pressure 0.2MPa)
		Lady	
	Nozzle position	Hip cleaning	Approx. 60mm~110mm
		Lady	
	Heater power	1600W	
	Safety device	Flow sensors, Water temperature sensors Temperature sensitive switches, Temperature fuse	
Rated power	1200W (inlet water temperature 15°C, flow rate 680 ml/min)		
Drying device	Wind speed	≥4m/s	
	Wind temperature	Four-stage adjustment (room temperature gear ~ about 55°C)	
	Drying heating power	250W	
	Safety device	Temperature controller, Temperature fuse	
Insulated Seat	Surface temperature	Four-stage adjustment (room temperature gear ~ about 40°C)	
	Seat heating power	45W	
	Safety device	Temperature sensor, Temperature fuse	
	Switch structure	Damping cushioning on seat and cover	

### Caution:

1. the water inlet water pressure in the above table is suitable for models without water tank.

2. with water tank model water pressure requirements:

Ceramic flushing water supply pressure range of 0.03 ~ 0.75MPa (static pressure); in order to achieve the best cleaning effect, cleaning water pressure ≥ 0.08MPa (dynamic pressure) and to ensure that the flow of water in the flow of 2.3l/10s or more, the highest water pressure ≤ 0.75MPa (static pressure).

## Warning



Dismantling is forbidden

Please do not disassemble, repair or transform this product without permission.

- \* May cause fire or electric shock.
- \* This product must be repaired by professionals.

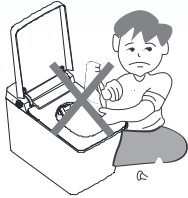

Immersion is forbidden

Please avoid installing it in a bathroom that is wet and prone to water immersion. Do not spray water on the product or rinse it with water.

- \* May cause fire or electric shock.

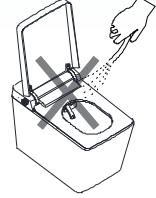

Grounding wire

The power outlet must have a reliable grounding wire. The power outlet should be equipped with a waterproof cover.

- \* May cause fire or electric shock.
- \* If there is no grounding, commission an electrical professional to install it and use it.



Immersion is forbidden

Please do not use multiple plugs on the same power socket, add additional cords or use extension cords.

- \* Touching the power socket with wet hands will cause electric shock.

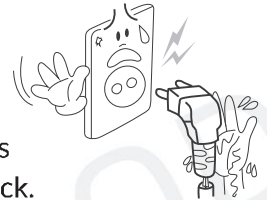

Forbidden

Do not pull or bend the connection line. Do not pull or tug on the power cord or the Integrated Toilet connection cord.

- \* Can cause the product to leak.
- \* Can cause the product to function abnormally.

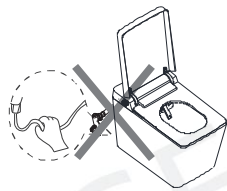

Forbidden

Please do not use multiple plugs on the same power socket, add additional cords or use extension cords.

- \* It may cause heat or fire.
- \* Please make sure the plug is plugged in.

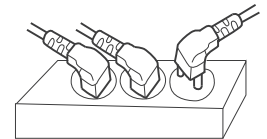

Must be done

Do not spray urine directly on the wash nozzle and drying outlet.

- \* directly on the wash nozzle and drying outlet

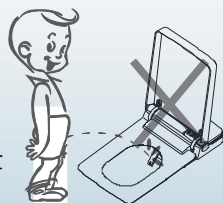

Forbidden

Do not block the warm air outlet, infrared induction window or remote control receiving window with hands or other objects.

- \* May cause abnormal function.
- \* May cause fire or electric shock.



## Warning



Forbidden

In case of malfunctioning, do not continue to use the product. Unplug it from the power source and close the water inlet angle valve.

- \* If you continue to use it in a faulty condition, it may cause problems such as fire, electric shock or water seepage in the room.

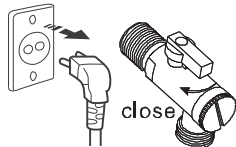

Discarding fire works is forbidden

Please do not put cigarette butts, ashes or any burning objects near the product or throw them into the bowl.

- \* May cause fire.



Must be done

When repairing the outside of the product or disassembling it, be sure to pull out the plug to ensure safety.

- \* May cause fire or electric shock.



Forbidden

Do not use in thunder and lightning, and unplug the power supply.

- \* May cause accidents or malfunctions.

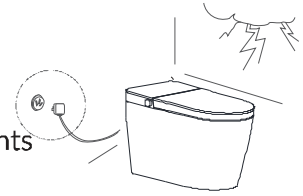

Forbidden

Do not apply force or shock, stand on the cover, seat cover or other parts of the product, or place heavy objects.

- \* Children should not play with this product.
- \* May damage the product, resulting in product failure or personal injury.



Forbidden

Please pay attention to low temperature burns.

- \* Please do not use the [High] and [Medium] gears of the seat temperature and wind temperature for a long time, otherwise there is a danger of scalding.
- \* People (including children) with physical, perceptual, or intellectual disabilities should be accompanied when using the product, otherwise prolonged use may cause personal injury.

## Caution



Forbidden

When cleaning plastics, use neutral cleaners, do not use bleach, benzene, paint thinner, stain remover, cresol, etc.

- \* Can cause plastic to deform and crack, resulting in personal injury.
- \* May damage water pipes and cause water leakage.



Forbidden

Do not open and close the cover and seat by force.

Do not manually open or close the cover and seat cover in reverse during the automatic cover flip.

- \* Parts may be damaged.



**⚠ Caution**



Please use clean water, do not use industrial water or polluted water.

Forbidden

- \* May cause cystitis, dermatitis.
- \* Can cause electric shock and fire due to internal corrosion of machinery.

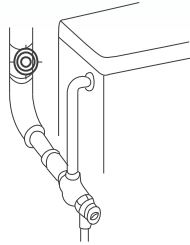

Please avoid direct sunlight on the product.

Do not place heaters or warmers, etc. near this product.

Must be done

- \* It will cause discoloration, aging, and deformation of the product, leading to product damage.

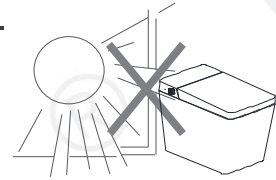

Please do not connect the power supply of this product until the product is installed, the water pipe is connected and the water valve is opened.

Forbidden

- \* If violated, it will cause failure.



If the product will not be used for a long period of time or when cleaning the product, unplug it from the power supply and close the angle valve.

Must be done

- \* Avoid creating a risk of water leakage.

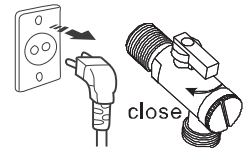

Only flush toilet paper. Do not flush feminine hygiene products, wipes or any other items that may clog the product.

Forbidden

- \* Causes clogging of Integrated toilets and indoor flooding.

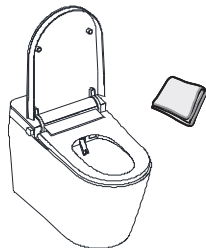

Do not lean back hard on the cover.

Forbidden

- \* It may cause cover to break or crack



Do not place seat cushions or seat aids for toddlers on the seat.

Must be done

- \* It may cause some functions to be unavailable.

## Precautions for Use

Anti-freezing measures in winter (when the ambient temperature is lower than 4°C)

If you will not be using the product for a long period of time, such as travelling or business trip. a. Close the water supply angle valve, then press the flush button on the remote control to drain the connection line and ceramic more than twice.

b. After draining the water for 30 seconds, please make sure you unplug the leakage protection power cord.

2. In cold winter, when the product is transported over a long distance or stored for a long period of time, freezing may occur in the remaining water inside the product.

To prevent damage caused by freezing, please take anti-freezing measures.

**Treatment of the product after freezing:**

**1. Place the product in a warm room for 30min and wait for it to thaw naturally before turning on the water and electricity.**

**2. If freezing occurs and water does not come out of the nozzle, a cloth soaked in hot water can be put over the water supply hose of the product or the connecting part of the water supply pipe to thaw it out (please do not pour hot water on the water supply hose of the Smart Toilet or blow hot air on it).**



## When turning on the rear wash, feminine wash and drying...

When turning on the rear wash, feminine wash and drying functions, please make sure to stay close to the seat sensor area, otherwise the above functions cannot be turned on.

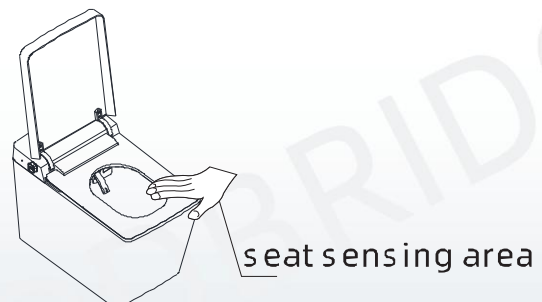

**Woodbridge warrants its products as listed in below to be free of material and workmanship defect, subjected to the limitations set forth in this limited warranty.**

- Bathtub, Whirlpool/Air Bubble Massage Tub, Cold Plunge, 1 Year limited to be free of defects in material and workmanship.
- Sauna room and Sauna Tent : 1 Year limited to be free of defects in material and workmanship.
- Toilet and Bidet : 1 Year limited to be free of defects in material and workmanship.
- Faucet : 1 Year limited to be free of defects in material and workmanship.
- Vanity and vanity top : 1 Year limited to be free of defects in material and workmanship.
- Granite, Marble, Engineered Quartz Vanity Top : 1 Year limited to be free of defects in material and workmanship.
- Medicine Cabinet, LED Mirror : 1 Year limited to be free of defects in material and workmanship.
- Sink : 1 Year limited to be free of defects in material and workmanship.
- Solid Surface Shower Wall Panel, Shower Base : 10 Years limited warranty to be free from material defects.
- Drain Cover and PVC Drain : 1 Year limited to be free of defects in material and workmanship.
- Shower Door : Lifetime warranty on glass components and 1 Year limited on other hardware.

**This limited warranty is non-transferable and only applies to products purchased and installed in the United States and Canada.**

This limited warranty excludes all industrial, commercial and business usage. Proof of purchase (original sales receipt) from the original purchaser, Description and pictures of defect, model number or model description must be provided to Woodbridge Bath for all warranty claims and Woodbridge Bath IS NOT responsible for labor cost, removal or installation costs.

This limited warranty shall not apply to goods which have been subject to accident, negligence, improper installation, product abuse, product misuse, or use of cleaners containing abrasives, alcohol or other organic solvents, whether performed by a contractor, service company, or yourself, are excluded from this warranty.

This warranty does not cover surface damaged caused by use of chemicals that break through or dissolve the surface finish or damage caused by the accidental dropping of sharp or heavy objects. Improper care and use of abrasive cleaners and will void the warranty.

During this limited warranty period if a malfunction occurs and after inspection it is determined that a defect developed during normal use, Woodbridge will as at its election proceed with any of the following options:

- (1) **repair or replace the defective part(s) or product(s) at cost**
- (2) **issue a refund of the original purchase price of the product(s) (Valid within 30 days from the date of purchase)**
- (3) **issue a credit to be applied toward the purchase of a new product. Shipping/delivery charges may apply and are in sole discretion.**

**Caution:**

NEVER use cleaners containing abrasive cleaners, ammonia, bleach, acids, waxes, alcohol, solvents or other products that are not recommended for Chrome finish will void the warranty.

Woodbridge products should be installed by a fully insured and licensed contractor only. Installation by anyone other than fully insured and licensed contractor will void this limited warranty.

## RESPONSIBILITIES OF OTHERS

Inspecting the unit prior to installation is the responsibility of the installer or building contractor who acts on behalf of the user. They are responsible for ensuring the unit is free of defect or damage. Notices are placed on the unit and on the shipping carton advising the installer of this responsibility. In the event of a problem, the unit must not be installed. Woodbridge is not responsible for failures or damage that could have been discovered, repaired, or avoided by proper inspection and testing prior to installation.

Damage occurring in transit is the responsibility of the carrier. The user or installer MUST open the crate and inspect the unit for damage when it is delivered. If damage is discovered, it must be reported immediately to the seller and the carrier in writing, and an inspection requested. Failure of the carrier to respond should be reported to the seller and the carrier. Your freight claims should be filed promptly thereafter.

This limited warranty does not cover any liability for consequential or incidental damages, all of which are hereby expressly disclaimed, or the extension beyond the duration of this limited warranty of any implied limited warranties, including those of merchant ability or fitness for an intended purpose.

## DISCLAIMER

Except as expressly provided, there shall be no warranty or obligation, express or implied, oral or statutory. No dealer or other person has the authority to make any warranties or representations concerning our products. In no event shall we be held responsible for any such warranties or representations.

Some states/provinces do not allow limitations on how long an implied warranty lasts, or the exclusion or limitation of special, incidental or consequential damages, so these limitations and exclusions may not apply to you. This warranty gives you specific legal rights, you may also have other rights which vary from state/province to state/province.

**To obtain warranty and replacement parts, please send e-mail to [help@woodbridgebath.com](mailto:help@woodbridgebath.com) with the original receipt information, Woodbridge will determine whether to repair or replace your product, issue a refund or issue a credit.**

**IMPORTANT!**

**DO NOT USE:** Abrasive cleaners such as: acid, ammonia, bleach, and similar solutions. Use of such solutions may cause corrosion, finish peeling, and/or dull the surface.

**DO NOT USE:** Abrasive sponges or cloth. Never use steel, wool, or wired brushes that will permanently scratch the

---

**Retain these installation instructions for future reference!**

---

Thank you for using WOODBRIDGE products!

**WOODBRIDGE<sup>®</sup>**

California (Norwalk) Distribution Center  
15600 Blackburn Ave, Norwalk, CA 90650

New Jersey (Somerset) Distribution Center  
635 Pierce St, Somerset, NJ 08873

Florida (Orlando) Distribution Center  
13645 S Orange Ave, Orlando, FL 32824

Canada (Ontario) Distribution Center  
615 Orwell Street, Unit B, Mississauga, ON L5A2W4, Canada

Please don't hesitate to contact us if you have any questions or concerns.

Customer Service Phone: 562-229-0088. (Monday - Friday 9 AM - 5 PM Pacific Time)

Or Email: [help@woodbridgebath.com](mailto:help@woodbridgebath.com)

# NOTE

---

---

---

---

---

---

---

---

---

---

---

---

---

---

---

---

---

---

---

---

---

---

---

---

---

---

---

---

---

---



WOODBRIDGE



WOODBRIDGE



WOODBRIDGE