

INSTALLATION AND CARE GUIDE

WOODBIDGE[®]

WOODEN BATHTUB

Model:WB1018



READ ALL INSTRUCTIONS BEFORE UNPACKING THE PRODUCT

INSTRUCTIONS THAT, IF IGNORED COULD RESULT IN DEATH OR SERIOUS INJURY CAUSED BY INCORRECT HANDLING OR INSTALLATION OF THE PRODUCT. THESE INSTRUCTIONS MUST BE OBSERVED FOR SAFE INSTALLATION.

CAUTION!



**TWO PERSON
LIFT REQUIRED**

**2 PEOPLE ARE REQUIRED TO LIFT AND DURING
ENTIRE INSTALLATION OF THIS PRODUCT**

Limited warranty is void on any commercial installation

We are not responsible for local code compliance for this product. Building and plumbing codes may vary from state-to-state in accordance to your location. We are not responsible for providing any compliance certifications.

Under no circumstances we are shall not be liable for any and all incidental damages sustained in connection with this product.

Neither manufacture, nor distributor, nor retailer is responsible for water damage or flood caused due to use of this product.

Under no circumstances, we shall not be liable for any and all fees cost of installation/reinstallation/removal, subsequent damage or transportation in case of the product defect.

Customer Service Phone: 562-229-0088. (Monday - Friday 9 AM - 5 PM Pacific Time)

Or Email: help@woodbridgebath.com

20230718 REV. 1



Chrome Drain



Top/Inside View



Lid



Seat

Parts Included:

- Matching Seat x1
- Matching Lid x2
- Chrome Pop-up Drain x1

Product Details:

Model: WB1018

Size: (L)59" X (W)31-1/2" X (H)23-5/8"

Capacity: 1 person

Material: Rubber Wood

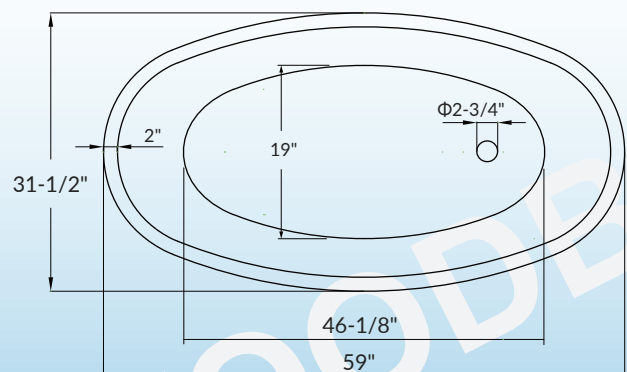
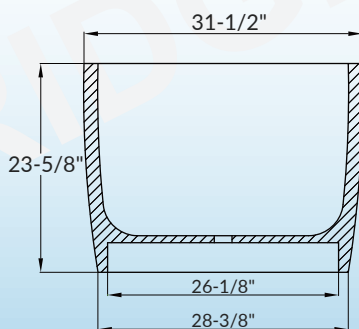
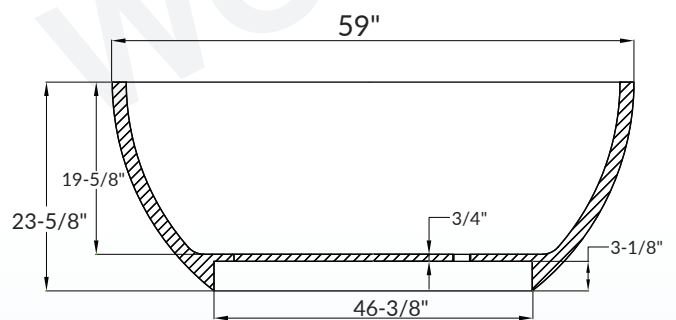

TOOLS REQUIRED FOR INSTALLATION (NOT INCLUDED)

OTHER TOOLS MAY BE REQUIRED

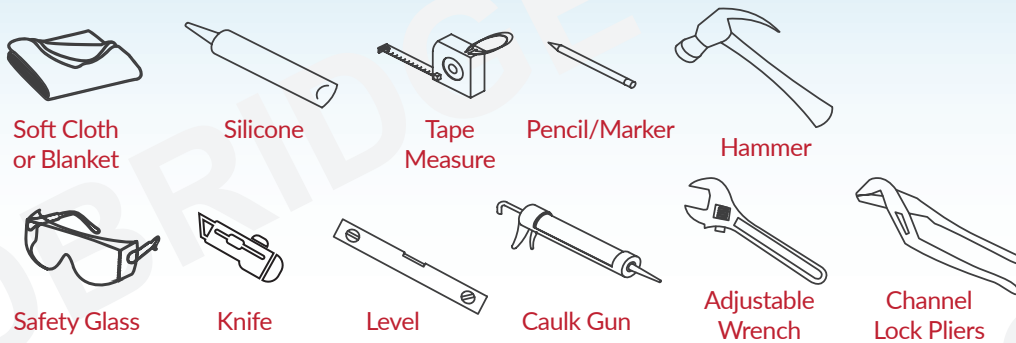

Inspect the bathtub for any damages. If any damage is found please contact your retailer.

Carefully, remove the tub from it's crate/box.

Important Note: Bathtub must be carried by a minimum of 2 adult people in upside down position only. Do not carry the bathtub by its panel.

To avoid scratches or damages to the bathtub be sure to set it on cardboard with soft blanket on top of the cardboard.

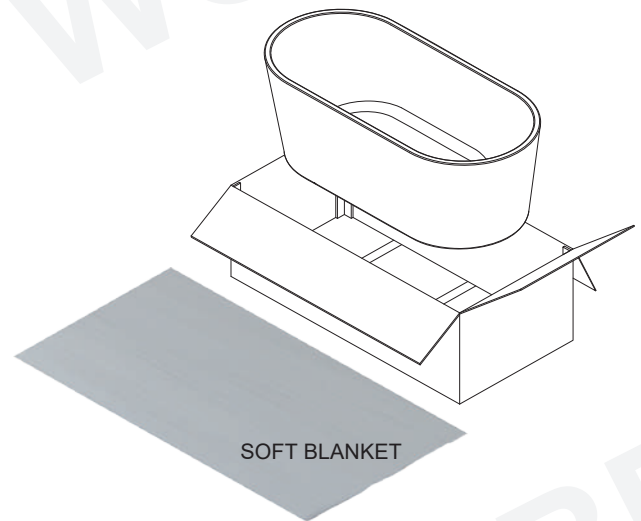

1. Leak test before final installation

Very Important! Before proceeding with installation, please check that push pop-up drain is properly sealed and tightened. Push the pop-up into a close position and fill the bathtub with cold water and check if drain holds the water or any leaks from the bottom of the drain.

Check for any leaks around the drain. (NOTE: Due to surface tension, it is normal for a small amount of water to pool around the drain)

If a leakage occurs please disassemble the drain line, you can apply a plumbing putty/silicone caulk to fix the leakage.

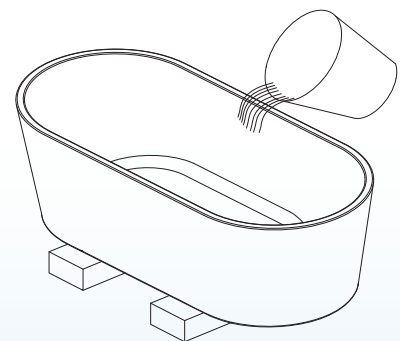

FREESTANDING INSTALLATION

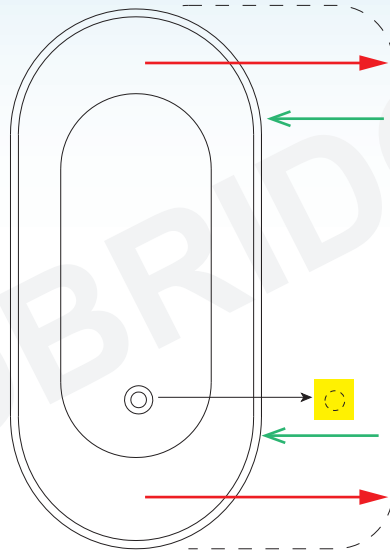

1. Clean, level and prepare the floor for installation, Place the tub in the exact installed location on the floor and trace the outline of the bathtub with pencil and mark the drain hole location on the floor. Move the tub away so that the plumbing can be installed.

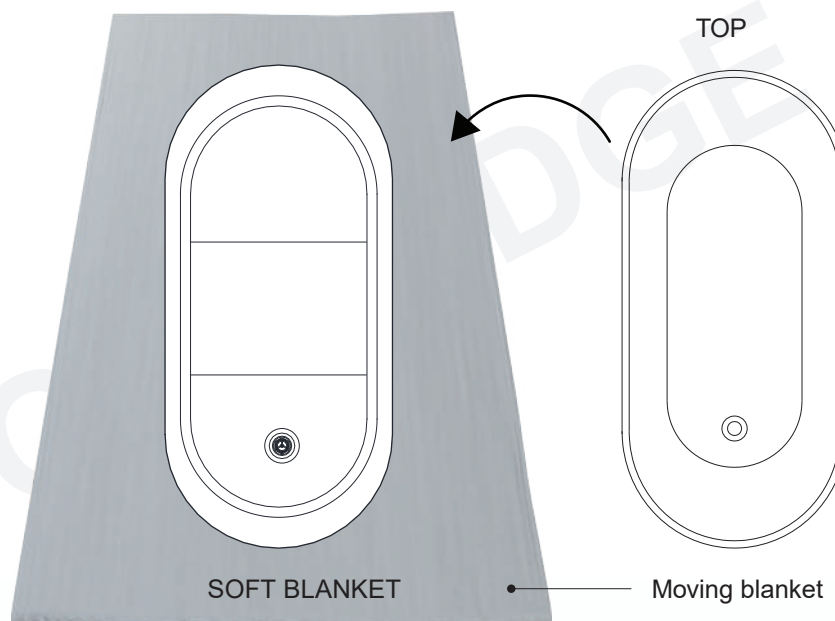

2. Turn bathtub upside down and set it on a non-abrasive mat, blanket, or cardboard to prevent any scratches on tub rim.
3. Install an 1-1/2" tail piece along with the corresponding flanged washer and 1-1/2" nut to the drain body.
4. Measure and cut the tail piece to the appropriate length to reach the trap adapter. When setting the tub drain, insert tail piece with 1-1/2" slip joint and rubber washer into the trap adapter and tighten properly.

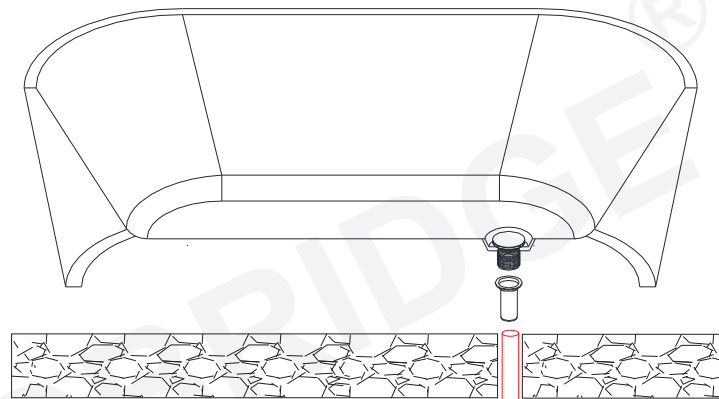
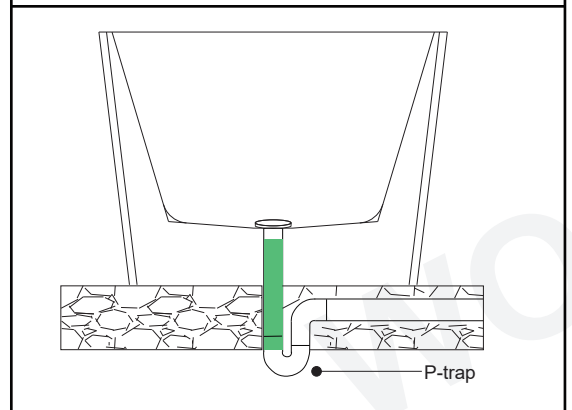
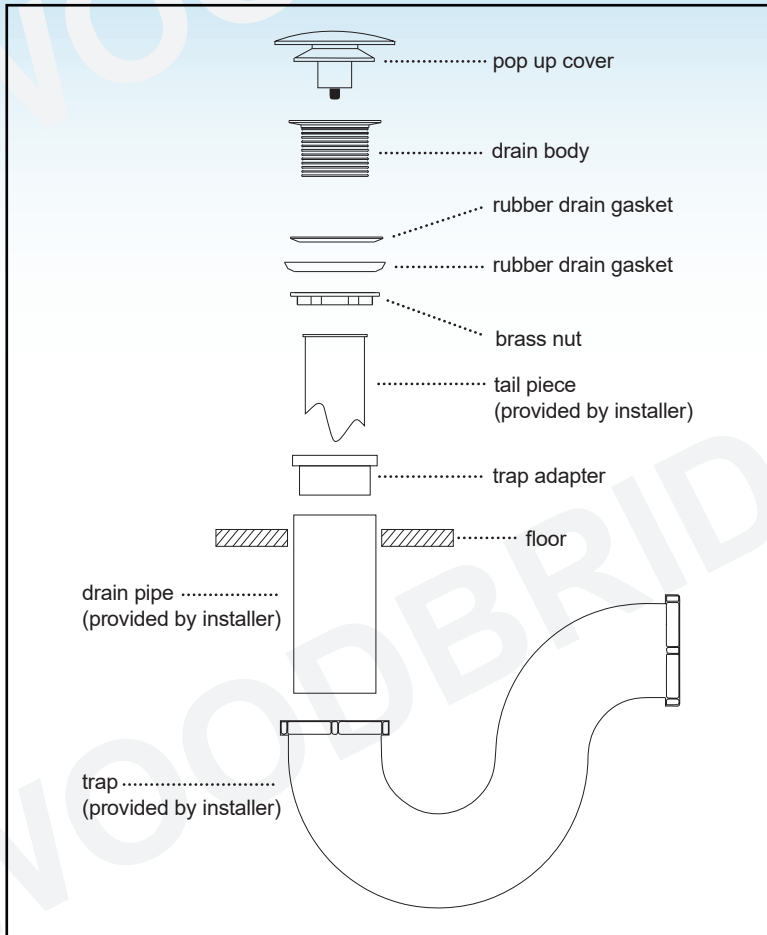

5. Flip the tub over and carefully set the tub into position with tail piece assembly to P-trap and connect to the drain.

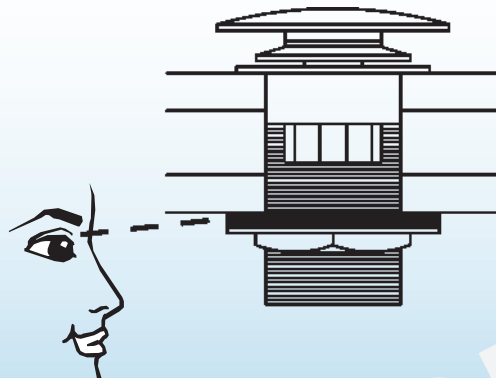

6. Fill the tub with water and then drain the tub while inspecting the waste connection below the floor for any leaks. Access from below will be necessary for this step.

Note:

If installing on a concrete slab where no underfloor access or cannot move drain. You may consider following option.

- Optional flexible drain hose from plumbing hardware or home improvement store may be used (Woodbridge will not supply this flexible hose). Connect one end attaches to the bathtub drain and the other end needs to be attached to the floor drain by using a transition piece.
- Optional Island tub drain may also be used.
- Create a bridge from bathtub drain to floor drain by certified plumber only because any mis-joint or loosen on connection will cause leaks.

INSTALLATION ON SLAB FLOOR (NO UNDERFLOOR ACCESS)

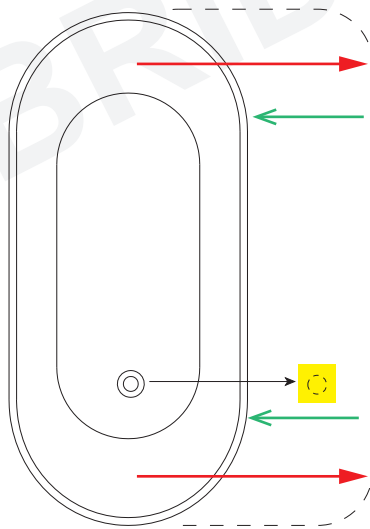

1. Clean, level and prepare the floor for installation, Place the tub in the exact installed location on the floor and trace the outline of the bathtub with pencil and mark the drain hole location on the floor. Move the tub away so that the plumbing can be installed.

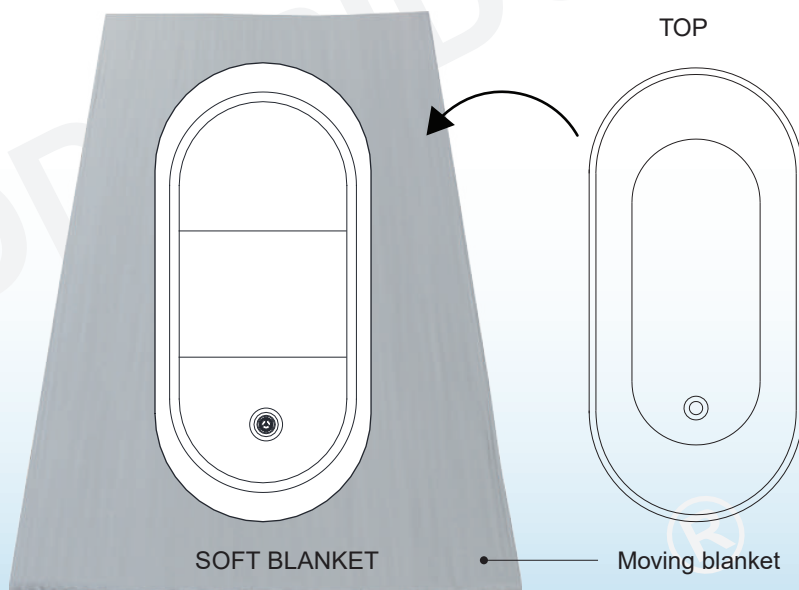

2. Turn bathtub upside down and set it on a non-abrasive mat, blanket, or cardboard to prevent any scratches on tub rim.

3. Measure the actual distance from drain into drain pipe(not provided)on floor and the drain pipe should extend approximately 1" above the finish floor. Use a drain adapter (not provided) if necessary.

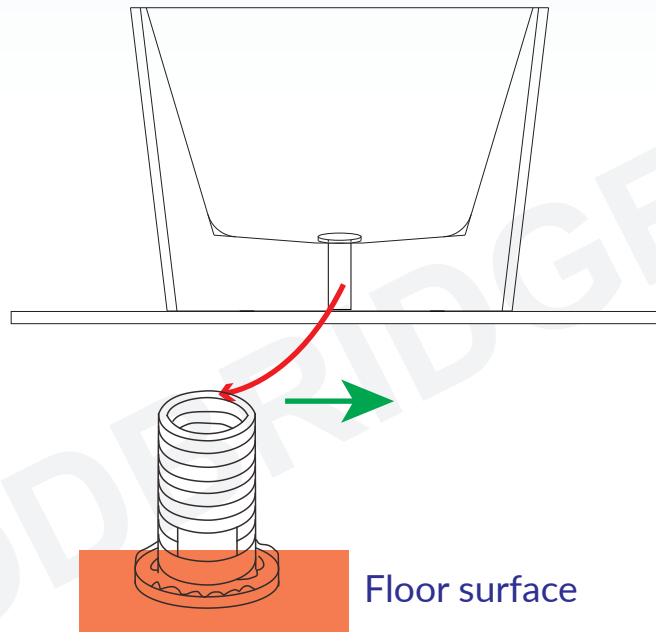

4. Clean the surrounding of the drain pipe with cloth in preparation of setting the drain, the area should be dry and free of any debris. Apply a bead of clear silicon or plumber putty around the drain body and pass it through the drain hole, also apply plumber putty to the washer and slide it over the bottom of the drain body.

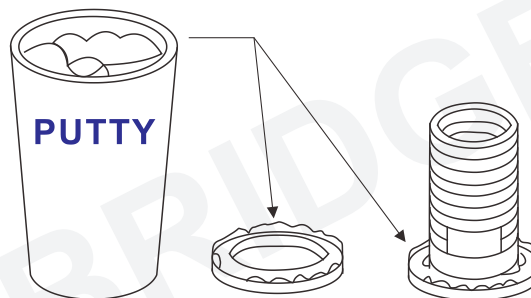

5. Install 1 ½" rubber slip gasket over the drain waste vent.

IMPORTANT SAFETY RULES

ATTENTION! ALWAYS FOLLOW THESE PRECAUTIONS WHEN USING A BATHTUB

- ⚠ Warning** The bathtub must be installed and used as described in this manual
- ⚠ Warning** Use caution when entering or exiting the bathtub
- ⚠ Warning** Do not permit children or persons with infirmities to use the bathtub without supervision of an adult
- ⚠ Warning** People using any medications or having adverse medical history must consult a physician prior to use of the bathtub to avoid potential hyperthermia and possible drowning
- ⚠ Warning** Water temperature over 100°F may cause hyperthermia and/or other health problems. Check water temperature and adjust it for your personal comfort
- ⚠ Warning** Never use bathtub while intoxicated, after taking meals or any alcoholic beverages. Consuming alcoholic beverages before or during bathing will cause drowsiness and may result in hyperthermia, loss of consciousness, or even drowning
- ⚠ Warning** If you are pregnant or you feel that you are may be pregnant, consult your doctor before using the bathtub
- ⚠ Warning** Never use any electrical devices such as hair dryer, lamp, telephone, tv, radio, or others within 5 feet of the bathtub
- ⚠ Warning** Do not overfill the bathtub before enetering. Entering the bathtub when filled will cause overflow and slippery conditions. Use extreme caution when entering and exiting

IMPORTANT!

DO NOT USE: Abrasive cleaners such as: acid, ammonia, bleach, and similar solutions. Use of such solutions may cause corrosion, finish peeling, and/or dull the surface.

DO NOT USE: Abrasive sponges or cloth. Never use steel, wool, or wired brushes that will permanently scratch the

Retain these installation instructions for future reference!

Thank you for using WOODBRIDGE products!



Please don't hesitate to contact us if you have any questions or concerns.

Customer Service Phone: 562-229-0088. (Monday - Friday 9 AM - 5 PM Pacific Time)

Or Email: help@woodbridgebath.com