

INSTALLATION MANUAL

WOODBIDGE[®] Solid Surface Shower Wall Kits and Panels

Model:
BTH-6032-WH64

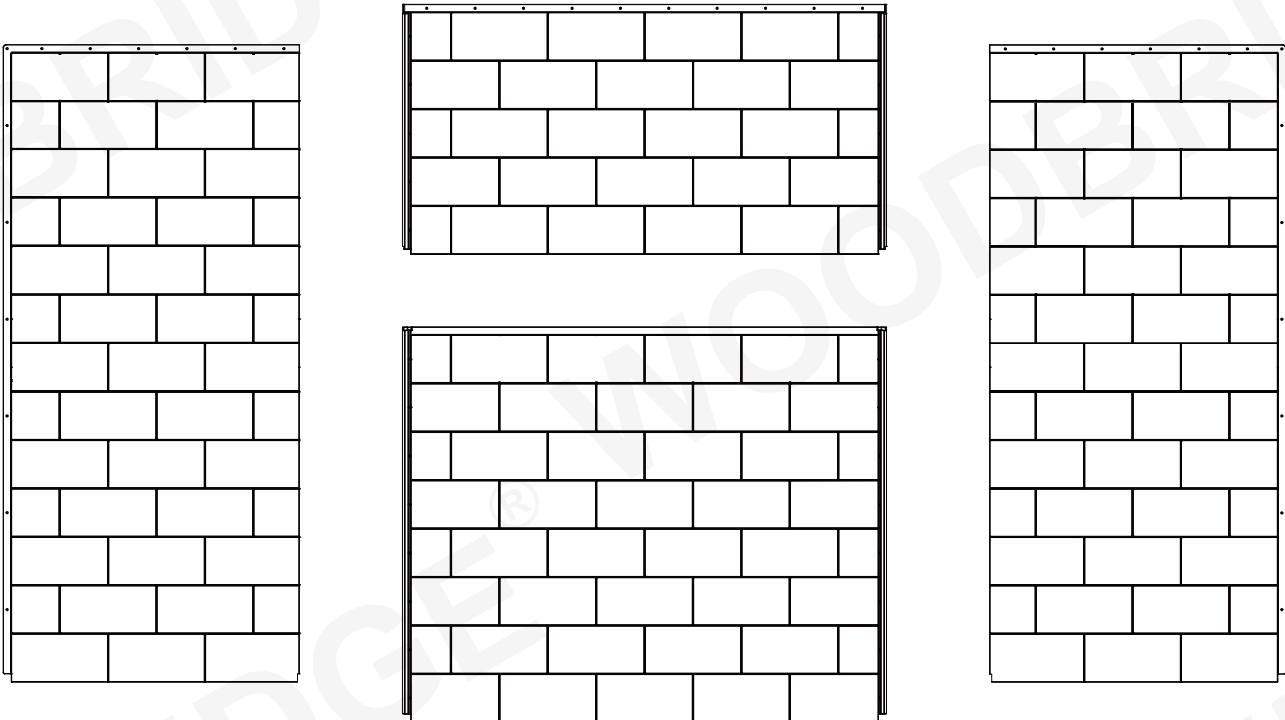

READ ALL INSTRUCTIONS BEFORE UNPACKING THE PRODUCT

INSTRUCTIONS THAT, IF IGNORED, COULD RESULT IN DEATH OR SERIOUS INJURY CAUSED BY INCORRECT HANDLING OR INSTALLATION OF THE PRODUCT. THESE INSTRUCTIONS MUST BE OBSERVED FOR SAFE INSTALLATION.

CAUTION!



**TEAM LIFTING
REQUIRED**

**TEAM LIFTING REQUIRED TO LIFT AND DURING
ENTIRE INSTALLATION OF THIS PRODUCT**

Please Call Customer Support: 562-229-0088. (Monday - Friday 9 AM - 5 PM Pacific Time)

Or Email: help@woodbridgebath.com

1. Product Specifications

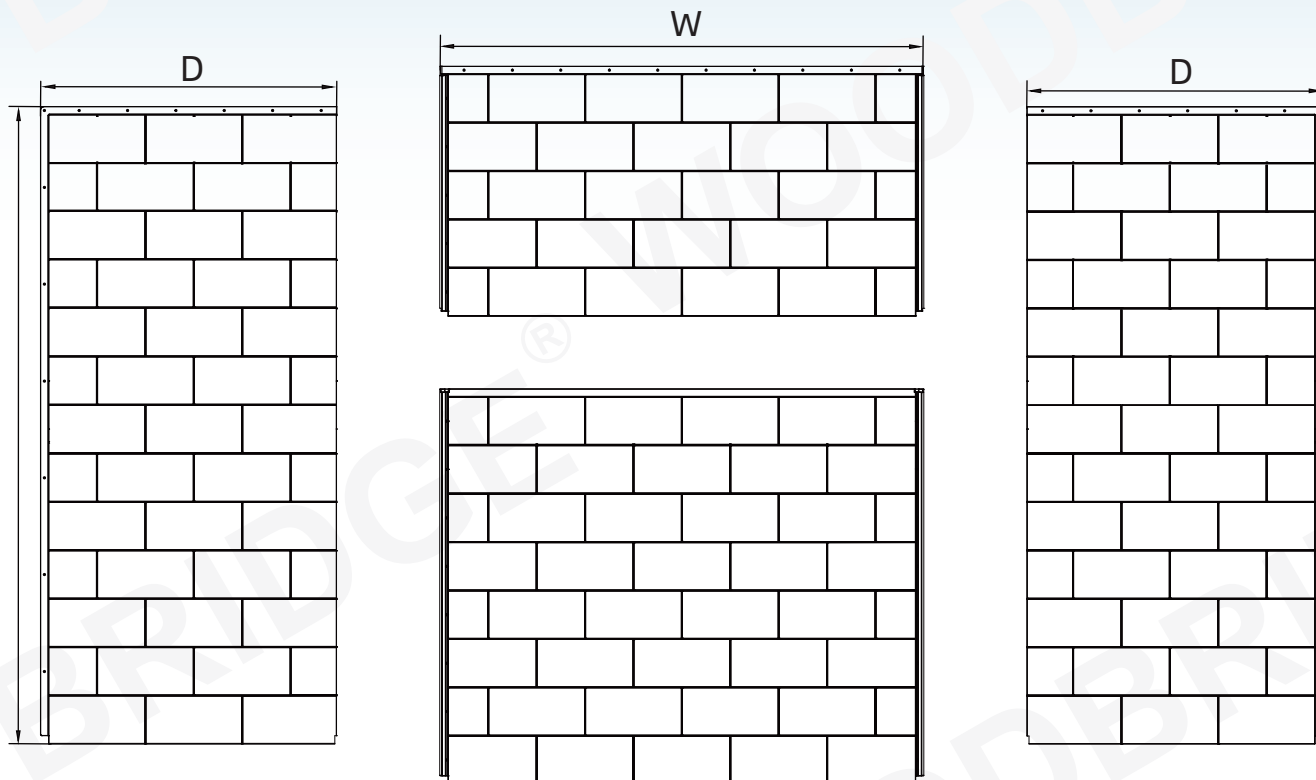

Size Chart		
Width (inch)	Height (inch)	Depth (inch)
60	64	32

2. Safety Guidelines

Indicates that equipment or property damage can result if instructions are not followed.

- **Read and Understand the Manual**

who installs or maintains this product to fully understand and follow proper installation and maintenance procedures. Be aware of the inherent dangers in the use of power tools when installing this product. Read and understand all warnings, cautions, and important notices in this manual.

- **Work safely**

DO NOT proceed if any doubt arises about the correct or safe method of performing any thing found in this or other manuals. The installation of this product can require the use of power tools. Do not use power tools without adequate training. If necessary, hire or consult a trained professional for expert assistance before continuing.

- **Use Proper Tools**

Always use proper tools that are in good, working condition during the installation of the WOODBRIDGE products. Using tools other than those listed could adversely affect the integrity of floors, pipes, walls, or this product and could result in water damage or other damage to floors, pipes, walls, or other portions of your building or home.

- **Do Not Use Nails**

The panels are mounted to walls with Adhesive(Clear or White) only. WOODBRIDGE recommends Adhesive(Clear or White) to mount this product, Never use hammers, nails, or screws. Hammers, nails, and screws could adversely affect the integrity of this product. Nails and screws could puncture the Wall Systems and Panels, resulting in water or other damage to floors, pipes, walls, or other portions of your building or home.

- **Inspect Before Cutting**

Make sure no electrical wiring or plumbing is present before cutting into a wall to install any accessories.

- **Use Proper Installation Methods**

Follow all instructions related to wall surface preparation. Failure to follow such instructions could cause the panels to detach from the wall surface after installation, resulting in personal injury, Failure to follow these instructions could result in water damage.

WARNING

Handling Hazard

According to the National Institute of Occupational Safety and Health, the recommended maximum safe lifting weight is 51 pounds, under perfect lifting conditions - mineral - free ground, steady blood - close to the body, straight back, load between knees and shoulders, and good grips. To avoid personal injury, always use these proper lifting techniques and have two people lift when panels weigh more than 51 lbs. DO NOT attempt to lift objects that are too heavy. When carrying a heavy load, seek assistance.

Room Temperature

Allow wall panels to adjust to room temperature for at least six hours before installation, and consult the Adhesive manufacturer's instructions for storage and surface preparation. The panels should be installed at temperatures not lower than 65°F. Panels should not be installed in areas where the temperature may drop below freezing (32°F). Failure to follow this recommendation could adversely affect the adhesive holding the panels to the wall. If the panels are not correctly adhered to the walls, they may fall off, posing a risk of injury to someone in or around the area.

Eye Protection

Ensure your own safety by using all personal protective equipment. To prevent eye injury, always wear protective glasses with side shields when using power tools. Additionally, ensure no one else can be injured by flying particles when using power tools.

Grab Bars

We recommend that shower compartments be equipped with support grab bars that comply with the most recent edition of ANSI - A117.1 requirements. Grab bars must be anchored to structural support (studs/joists) behind the panels. Do not rely solely on the panels for grab bar support.

Personal Protection

Ensure your safety by using all personal protective equipment, such as sturdy work boots (preferably with steel toes), gloves, and a hard hat if necessary. To prevent hearing damage, always wear ear protection, such as earmuffs or earplugs, when working with power tools.

Cutting Hazard

The installer of products may require the use of power tools. Keep your hands away from the cutting edge of any tool used during the installation of our product. Placing fingers near or around the cutting blades could result in serious personal injury.

Slipping Hazard

Do not install this product in the presence of water. Installing this product without thoroughly drying all surfaces, or in the presence of water, could cause you to slip and fall due to wet floors or spilled fluids. Personal injury may result from slips or falls. Before installation, dry all surfaces, including the floor, with a cloth or paper towel. Clean up any water or spilled fluids immediately.

Fire Hazard

Personal injury or death can result from a fire caused by flammable liquids or Adhesive. Cleaners or solvents can be highly explosive and result in personal injury or even death if not used properly. Clean up any flammable substance immediately. Sparks or open flames can cause flammable substances to ignite. **DO NOT** smoke while working with or near any flammable substance.

Solvent Hazard

Follow all manufacturer's safety instructions for Adhesive and denatured alcohol. Alcohol vapors are both flammable and hazardous to breathe. Adhesive vapors may irritate the eyes and nose. Personal injury can result from improper handling or use of products such as denatured alcohol. Always follow the manufacturer's recommendations for the safe use of these products. Ventilate any work area before applying Adhesive, cleaning agents, or solvents.

Fumes Hazard

The fumes from the Adhesive and solvents used by the installer can be harmful if used in an unventilated room. Always work in a well - ventilated area. To maintain proper ventilation, open windows and use exhaust fans. If adequate ventilation is not achievable or practical, use respiratory protective equipment.

Dust Hazard

When cutting or drilling products, use a dust collection method that prevents dust particles from dispersing into the air. Always work in a well - ventilated area. Always use an OSHA - approved dust mask when cutting, drilling, or sanding products.

Power Tool Hazard

To prevent personal injury or possible death, always follow the electrical safety recommendations of the power tool's manufacturer. Do not use power tools in an unsafe manner. Power tools should only be connected to a circuit protected by a ground fault circuit interrupter (GFI).

Shock Hazard

Never use electric power tools near water, condensation, or other liquids. Electric shock can cause severe burns, significant injuries, and even death. If an extension cord is required, always use an OSHA - approved extension cord. Power cords should only be connected to a circuit protected by a ground - fault interrupter (GFI).

Electrocution Hazard

Water and other liquids conduct electric current and can create a short circuit, resulting in injury or death. Keep all liquids away from electrical cords and power tools. **DO NOT** create a short circuit between a source of electricity and a liquid by being in contact with both simultaneously.

3. Required Tools



Level
(Recommended
Laser Level)

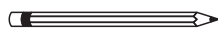

Pencil

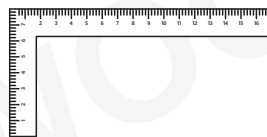

Square

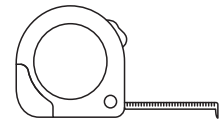

Tape measure

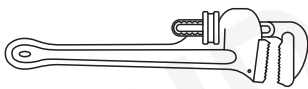

Pipe Wrench

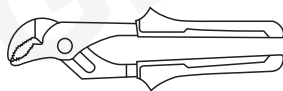

Slip Joint Pliers

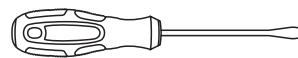

Screw Driver

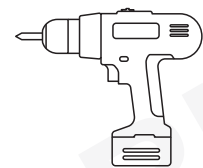

Woodworking Tools
(Required for Building a
Solid Wood Frame)

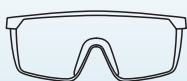

Personal
Safety Equipment



100% clear
silicone sealant

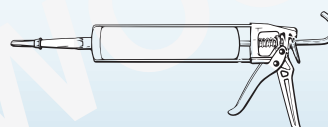

Caulking gun

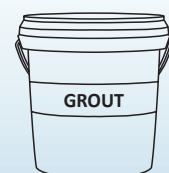

Mortar Mix
or Grout

4. INSTALLATION TIPS

- Open the bathtub & wall panels and inspect the product for any damage.
- Clean and scrape the surface of the floor and wall alcove. This space must be free of any debris in order to achieve proper adhesion with the thin - set mortar or structural adhesive.
- Install this product according to the installation instructions.
- Studs should be positioned roughly as shown.
- The positioning convex plates of the wall panel should be installed in the groove of the bathtub.

5. NOTE

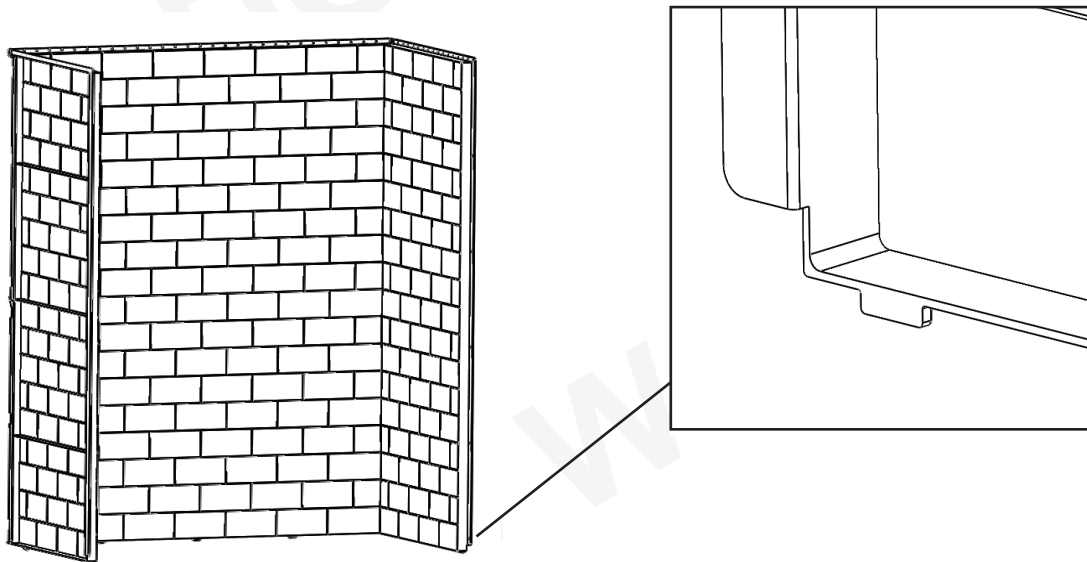

Note: If non - standard bathtub and base products are used (not provided by our company), the lower edge positioning tabs on the wall panels may need to be trimmed.

6. INSTALLING THE SHOWER PANEL

1. Apply adhesive to the back of the lower rear panel, align the lower edge positioning tabs with the bathtub's upper edge grooves, and secure it in place.



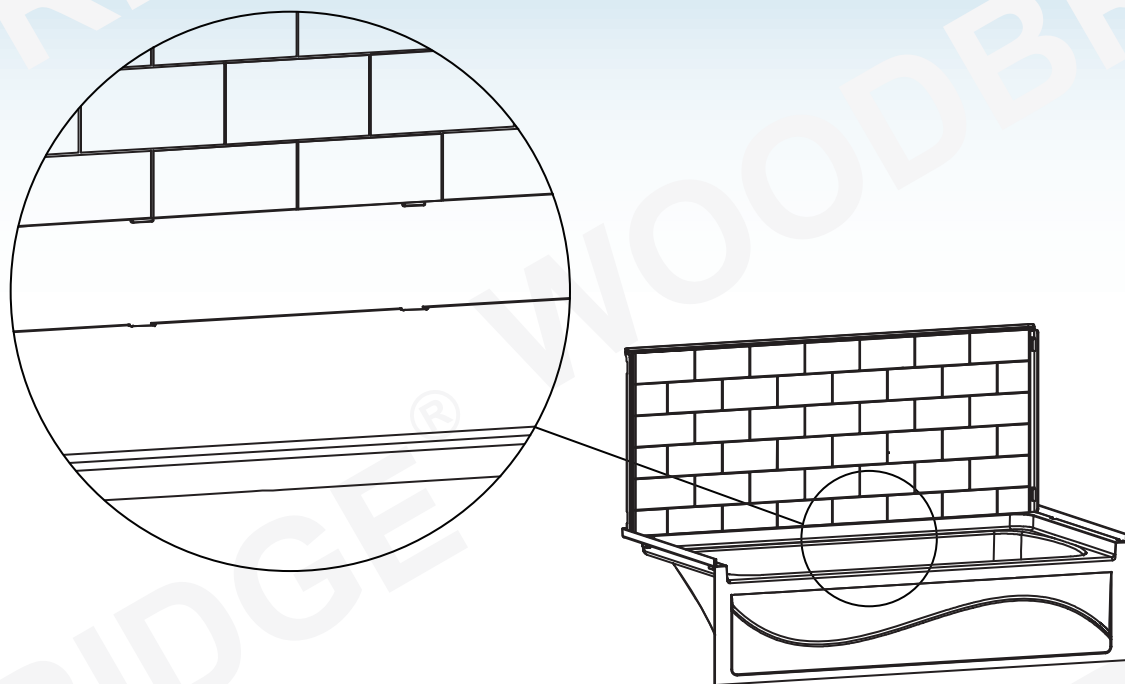

2. Apply adhesive to the back of the lower rear panel, align the lower edge positioning tabs with the bathtub's upper edge grooves, and secure it in place.

3. Apply adhesive to the grooves of the panel joints, insert the side panels into the rear panel's receptacle grooves, and align the gaps between the panels.

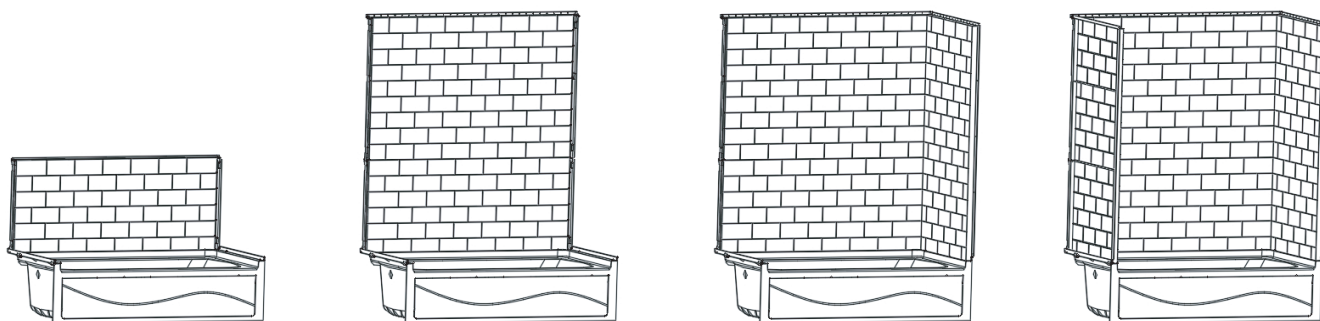

7. FIXED PANEL

After all the installations are completed, fix the wall panels with screws.



8. INSTALL FACUCET

1. Apply sealant tape and install a 1/2" spout nipple 1 - 1/8" (29 mm) from the wall. Apply sealant tape to the end.
2. Use a clean strap wrench to install the spout.
3. Apply sealant tape and install a 1/2" shower arm nipple 1 - 1/8" (29mm) from the wall. Apply sealant tape to the end.
4. Install the wall plate onto the shower arm. Install the shower arm.
5. Remove the plaster guard. Then turn on the water test the faucet.
6. Turn off the water and finish.

9. FINISH INSTALL

Clean the backs of each panel with denatured alcohol or another non - oil - based cleaning solvent. Do not use oil - based cleaners, such as mineral spirits, to clean the panels. The oil in the cleaner will prevent the panel from adhering properly to the wall.

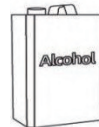

10. CARE AND MAINTENANCE

- Cleaning and maintenance of the shower wall panels should be performed regularly.
- The ideal cleaning time is right after shower use. Soap scum, lime, and other heavy soil could contaminate materials. The lack of cleaning and maintenance could result in damaging the surface of the wall panels and the core. Lack of cleaning shower walls could create discoloration of the wall panel.
- Shower walls should be cleaned regularly with a nonabrasive all - purpose household cleaner or window cleaner. Always test your cleaning solution on an inconspicuous area before applying it to the entire surface.
- Avoid using abrasive cleaners, scouring powders, grit, acid, acetone, alkaline, and ammonia.

Woodbridge warrants its products as listed in below to be free of material and workmanship defect, subjected to the limitations set forth in this limited warranty.

- Bathtub, Whirlpool/Air Bubble Massage Tub, Cold Plunge, Wooden Tub: 1 Year limited to be free of defects in material and workmanship.
- Sauna room and Sauna Tent: 1 Year limited to be free of defects in material and workmanship.
- Toilet and Bidet: 1 Year limited to be free of defects in material and workmanship.
- Faucet: 1 Year limited to be free of defects in material and workmanship.
- Vanity and Vanity Top: 1 Year limited to be free of defects in material and workmanship.
- Granite, Marble, Engineered Quartz Vanity Top: 1 Year limited to be free of defects in material and workmanship.
- Medicine Cabinet, LED Mirror: 1 Year limited to be free of defects in material and workmanship.
- Stainless Steel Sink: 1 Year limited to be free of defects in material and workmanship.
- Solid Surface Shower Wall Panel, Shower Base: 10 Years limited warranty to be free from material defects.
- Drain Cover and PVC Drain: 1 Year limited to be free of defects in material and workmanship.
- Shower Door: Lifetime warranty on glass components and 1 Year limited on other hardware.

This limited warranty is non-transferable and only applies to products purchased and installed in the United States and Canada

This limited warranty excludes all industrial, commercial and business usage. Proof of purchase (original sales receipt) from the original purchaser, Description and pictures of defect, model number or model description must be provided to Woodbridge Bath for all warranty claims and Woodbridge Bath IS NOT responsible for labor cost, removal or installation costs.

This limited warranty shall not apply to goods which have been subject to accident, negligence, improper installation, product abuse, product misuse, or use of cleaners containing abrasives, alcohol or other organic solvents, whether performed by a contractor, service company, or yourself, are excluded from this warranty.

This warranty does not cover surface damaged caused by use of chemicals that break through or dissolve the surface finish or damage caused by the accidental dropping of sharp or heavy objects. Improper care and use of abrasive cleaners and will void the warranty.

During this limited warranty period if a malfunction occurs and after inspection it is determined that a defect developed during normal use, Woodbridge will as at its election proceed with any of the following options:

- (1) repair or replace the defective part(s) or product(s) at cost**
- (2) issue a refund of the original purchase price of the product(s) (Valid within 30 days from the date of purchase)**
- (3) issue a credit to be applied toward the purchase of a new product. Shipping/delivery charges may apply and are in sole discretion.**

Caution:
NEVER use cleaners containing abrasive cleaners, ammonia, bleach, acids, waxes, alcohol, solvents or other products that are not recommend for Chrome finish will void the warranty.
Woodbridge products should be installed by a fully insured and licensed contractor only. Installation by anyone other than fully insured and licensed contractor will void this limited warranty.

RESPONSIBILITIES OF OTHERS

Inspecting the unit prior to installation is the responsibility of the installer or building contractor who acts on behalf of the user. They are responsible for ensuring the unit is free of defect or damage. Notices are placed on the unit and on the shipping carton advising the installer of this responsibility. In the event of a problem, the unit must not be installed. Woodbridge is not responsible for failures or damage that could have been discovered, repaired, or avoided by proper inspection and testing prior to installation.

Damage occurring in transit is the responsibility of the carrier. The user or installer MUST open the crate and inspect the unit for damage when it is delivered. If damage is discovered, it must be reported immediately to the seller and the carrier in writing, and an inspection requested. Failure of the carrier to respond should be reported to the seller and the carrier. Your freight claims should be filed promptly thereafter.

This limited warranty does not cover any liability for consequential or incidental damages, all of which are hereby expressly disclaimed, or the extension beyond the duration of this limited warranty of any implied limited warranties, including those of merchant ability or fitness for an intended purpose.

DISCLAIMER

Except as expressly provided, there shall be no warranty or obligation, express or implied, oral or statutory. No dealer or other person has the authority to make any warranties or representations concerning or its products. In no event shall be held responsible for any such warranties or representations.

Some states/provinces do not allow limitations on how long an implied warranty lasts, or the exclusion on limitation of special, incidental or consequential damages, so these limitations and exclusions may not apply to you. This warranty gives you specific legal rights, you may also have other rights which vary from state/province to state/province.

To obtain warranty and replacement parts, please send e-mail to help@woodbridgebath.com with the original receipt information, Woodbridge will determine whether to repair or replace your product, issue a refund or issue a credit.

IMPORTANT!

DO NOT USE: Abrasive cleaners such as: acid, ammonia, bleach, and similar solutions. Use of such solutions may cause corrosion, finish peeling, and/or dull the surface.

DO NOT USE: Abrasive sponges or cloth. Never use steel, wool, or wired brushes that will permanently scratch the surface.

Retain these installation instructions for future reference!

Thank you for using WOODBRIDGE products!

WOODBRIDGE®

California (Norwalk) Distribution Center
15600 Blackburn Ave, Norwalk, CA 90650

New Jersey (Somerset) Distribution Center
635 Pierce St, Somerset, NJ 08873

Florida (Orlando) Distribution Center
13645 S Orange Ave, Orlando, FL 32824

Canada (Ontario) Distribution Center
615 Orwell Street, Unit B, Mississauga, ON L5A2W4, Canada

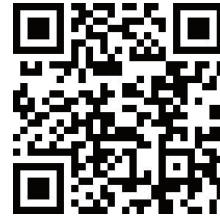

Please don't hesitate to contact us if you have any questions or concerns.

Customer Service Phone: 562-229-0088. (Monday - Friday 9 AM - 5 PM Pacific Standard Time)

Or Email: help@woodbridgebath.com

WOODBRIDGE® WOODBRIDGE® WOODBRIDGE® WOODBRIDGE® WOODBRIDGE® WOODBRIDGE® WOODBRIDGE® WOODBRIDGE® WOODBRIDGE® WOODBRIDGE®

WOODBRIDGE® WOODBRIDGE® WOODBRIDGE® WOODBRIDGE® WOODBRIDGE® WOODBRIDGE® WOODBRIDGE® WOODBRIDGE® WOODBRIDGE® WOODBRIDGE®